



# MAX3987 Evaluation Kit

## General Description

The MAX3987 evaluation kit (EV kit) is a fully assembled and tested PCB that demonstrates the capabilities of the MAX3987 8.5Gbps quad equalizer and preemphasis driver. The EV kit can be controlled using a PC to run the evaluation software or using DIP switches mounted on the EV kit to bias hardware pins. The included software is Windows® compatible and provides a simple graphical user interface (GUI) to configure all available device features. The software communicates with the EV kit through a USB port and provides three methods for configuration. The primary method is a simple point-and-click interface. The other debug interfaces allow direct register read/write operations, or software-controlled external pin programming. The data I/O traces on the EV kit are controlled impedance with matched lengths. All external connections are AC-coupled with standard SMA connectors for easy connection to test equipment.

Windows is a registered trademark of Microsoft Corp.

## EV Kit Contents

- ◆ MAX3987 EV Kit Board
- ◆ USB Cable
- ◆ AC/DC Power Supply

## Features

- ◆ SMA Connectors for Inputs and Outputs
- ◆ Controlled Impedance and Matched Length Input and Output Signal Traces
- ◆ Software- or Hardware-Controlled Operation
- ◆ Windows Software Provides Point-and-Click Access to MAX3987 Features
- ◆ Silkscreen Labels Identify All Signal Traces, Connectors, Jumpers, and LEDs
- ◆ Power Through USB or External 5V Supply

## Ordering Information

PART	TYPE
MAX3987EVKIT+	EV Kit

+Denotes lead(Pb)-free and RoHS compliant.

## Component List

DESIGNATION	QTY	DESCRIPTION
C1–C6, C8–C11, C14–C19, C23, C24, C29, C30, C39, C40	22	0.1µF ±10%, 16V ceramic capacitors (0402)
C7, C12, C13, C20, C26, C27, C28, C36	8	4.7µF ±5%, 6.3V multilayer ceramic capacitors (0603)
C21, C22	2	22pF ±5%, 25V NPO ceramic capacitors (0603)
C25, C35, C41	3	0.1µF ±20%, 16V X7R ceramic capacitors (0603)
C33, C34, C37, C38	4	10µF ±20%, 10V ceramic capacitors (1206)
D1	1	40V, 1A Schottky diode
DS1	1	Green LED
J1–J4, J6–J17	16	50Ω SMA connectors, tab contact, edge mount
J5	1	Dual-row (2 x 5) 10-pin vertical header, 0.1in centers

DESIGNATION	QTY	DESCRIPTION
J18	1	USB type-B single-port black right-angle receptacle
J19	1	Dual-row (2 x 3) 6-pin vertical header, 0.1in centers
J20	1	DC power jack, 2.1mm/5.5mm closed frame, right-angle PCB mount
JP1, JP2	2	3-pin vertical headers, 0.1in centers
R1, R2, R13, R14, R15	5	10.0kΩ ±5%, 1/16W resistors (0603)
R3	1	0.0Ω, 1/16W resistor (0603), shorted on PCB
R4	1	1.00MΩ ±5%, 1/16W resistor (0603)
R7, R8	2	33.2Ω ±1%, 1/16W resistors (0603)
R16	1	330Ω ±5%, 1/16W resistor (0603)
RP1–RP4	4	1kΩ ±5%, 1/16W quad resistor packs (quad 0402)



# MAX3987 Evaluation Kit

## Component List (continued)

DESIGNATION	QTY	DESCRIPTION
RP5–RP8	4	10k $\Omega$ $\pm$ 5%, 1/16W quad resistor packs (quad 0402)
SW1, SW2	2	8-position, 16-pin, low-profile DIP switches
SW3	1	4-pin momentary single-pole switch
TP1	1	Wire-loop plated-hole red test point
TP2	1	Wire-loop plated-hole black test point
U1	1	2-wire interfaced port expander (24 TSSOP) Maxim MAX7318AUG
U3	1	8.5Gbps quad equalizer (48 TQFN-EP*) Maxim MAX3987ETM+
U4	1	HCS08: 8-bit USB microcontroller (64 LQFP) Freescale MC9S08JM32CLH

\*EP = Exposed pad.

DESIGNATION	QTY	DESCRIPTION
U5	1	Low-dropout linear regulator (16 TSSOP-EP*) Maxim MAX1793EUE-33
U6	1	Low-dropout linear regulator (16 TSSOP-EP*) Maxim MAX1793EUE-25
X1	1	12.0000MHz $\pm$ 50ppm crystal (C <sub>L</sub> = 20pF) HC49SD
C42–C45, JPB1, TP3–TP6	—	Unpopulated components for test only
—	1	AC/DC adapter, output 5V DC at 2.6A PN DMS050260-P5P-SZ
—	1	USB type-A to type-B cable
—	4	Shunts
—	6	Rubber stand-offs
—	1	PCB: MAX3987 EVALUATION BOARD+ Rev A

### Quick Start

The MAX3987 evaluation kit (EV kit) is designed to operate in a stand-alone pin-bias hardware-controlled mode or a software-controlled mode requiring the use of a PC and software. In the pin-bias hardware-controlled mode,

the EV kit uses DIP switches SW1 and SW2 on the EV kit board to configure the MAX3987. If additional control is desired, a GUI software interface is provided to control the individual registers, allowing per-channel setting of items such as signal preemphasis and output amplitude levels.

# MAX3987 Evaluation Kit

Evaluates: MAX3987

## Pin-Bias Hardware Control Quick Start

- 1) Install a shunt on jumper JP\_ between 5V-ADAPTER and BOARD\_POWER to use an external 5V wall adapter.
- 2) Set the SW2-1 switch labeled I2C\_EN to the ON position to enable pin-bias mode. Note that in this mode the DIP switch settings control all 4 channels. To control the channels individually, software mode must be used.
- 3) Using the information in Tables 1, 2, and 3, set the remaining SW1 and SW2 DIP switches to configure the device for the desired mode of operation.

**Table 1. Output Drive Level Pin Programming**

PIN/POSITION	SILKSCREEN REFERENCE	FUNCTION	SWITCH POSITION OFF	SWITCH POSITION ON
SW1-1	OC_EN	Enable/Disable Offset Cancellation	Offset Cancellation Turned ON (Enabled)	Offset Cancellation Turned OFF (Disabled)
SW1-2 to SW1-4	(No Text)	—	—	—
SW1-5	A1	I <sup>2</sup> C Physical Address	Sets Up I <sup>2</sup> C Address: 0–F Hex Acceptable	
SW1-6	A2	I <sup>2</sup> C Physical Address	Sets Up I <sup>2</sup> C Address: 0–F Hex Acceptable	
SW1-7	A3	I <sup>2</sup> C Physical Address	Sets Up I <sup>2</sup> C Address: 0–F Hex Acceptable	
SW1-8	A4	I <sup>2</sup> C Physical Address	Sets Up I <sup>2</sup> C Address: 0–F Hex Acceptable	
SW2-1	I2C_EN	I <sup>2</sup> C Enable/Disable	Software-Controlled Operation	Pin-Bias Mode Operation
SW2-2	TX_EN	Power-On/Off Transmitter	All Outputs Powered ON	All Outputs Powered OFF
SW2-3	TX_LV0	Set Output Amplitude Bit 0	Drive Level Pin Programming (see Table 2)	
SW2-4	TX_LV1	Set Output Amplitude Bit 1		
SW2-5	TX_PE0	Set Preemphasis Level Bit 0	Global Output Preemphasis Control (see Table 3)	
SW2-6	TX_PE1	Set Preemphasis Level Bit 1		
SW2-7	SDSF	Select Signal-Detect Type	Select Slow-Response Signal Detect (SD1)	Select Fast-Response Signal Detect (SD2)
SW2-8	SQ	Enable/Disable Output Squelch and Signal Detect	Disabled	Enabled

**Table 2. Output Drive Level Pin Programming**

SW2-4 POSITION	TX_LV1 PIN VOLTAGE (V)	SW2-3 POSITION	TX_LV0 PIN VOLTAGE (V)	LV REGISTER VALUE	OUTPUT DRIVE LEVEL
ON	0	ON	0	00	Level 1 drive (minimum)
ON	0	OFF	3.3	01	Level 2 drive
OFF	3.3	ON	0	10	Level 3 drive (maximum)
OFF	3.3	OFF	3.3	11	Do not use this mode

**Table 3. PE Pin Programming**

SW2-6 POSITION	TX_PE1 PIN VOLTAGE (V)	SW2-5 POSITION	TX_PE0 PIN VOLTAGE (V)	PE REGISTER VALUE	PREEMPHASIS VALUE (dB)
ON	0	ON	0	00	0
ON	0	OFF	3.3	01	3
OFF	3.3	ON	0	10	7
OFF	3.3	OFF	3.3	11	11

# MAX3987 Evaluation Kit

- 4) Connect the 5V wall adapter power to the EV kit to power up the device and begin testing. Note that the control pins of the device are constantly read so any changes to the switches immediately affect operation of the device.
- 5) To begin testing, connect the signal source(s) to any pair of input SMA connectors (RX0–RX3). The differential input-signal voltage can be between 200mV<sub>P-P</sub> and 1600mV<sub>P-P</sub> with a data rate from 1Gbps to 8.5Gbps. The output signal(s) can be observed by connecting the associated pair of output SMA connectors (TX0–TX3) to a high-speed oscilloscope with 50Ω termination.
- 6) Figures 1 and 2 show setup examples for testing and evaluating the device's equalization and preemphasis features.

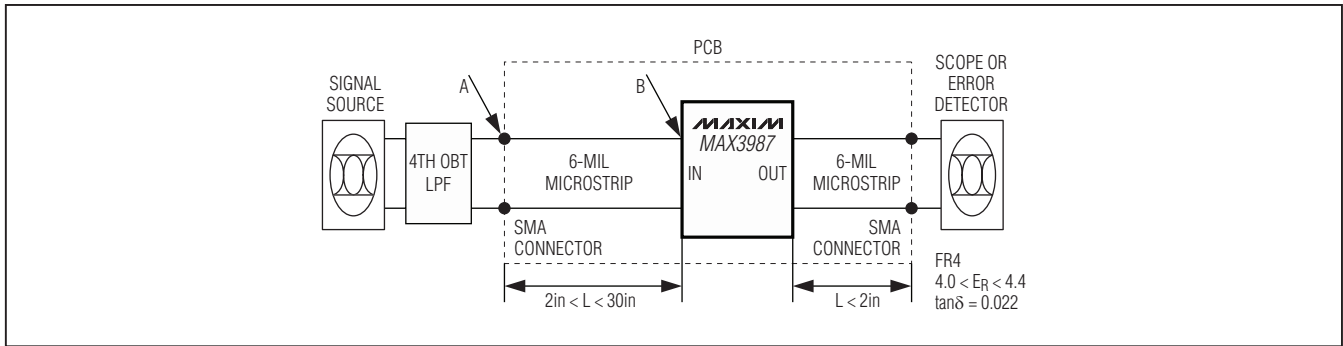

Figure 1. Receive Equalizer Test Setup. The points A and B are referenced for AC parameter test conditions. The filter is a lowpass fourth-order Bessel-Thompson (4th OBT LPF) or equivalent ( $BW = 0.75 \times \text{bit rate} \pm 10\%$ ).

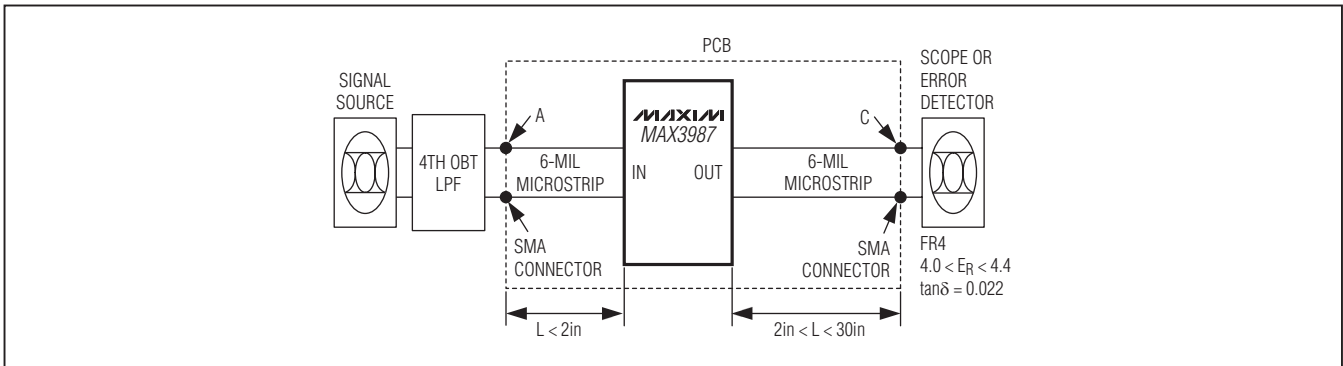

Figure 2. Preemphasis Test Setup. The points A and C are referenced for AC parameter test conditions. The filter is a lowpass fourth-order Bessel-Thompson (4th OBT LPF) or equivalent ( $BW = 0.75 \times \text{bit rate} \pm 10\%$ ).

# MAX3987 Evaluation Kit

## Software Control Quick Start

**Note:** In the following sections, software-related items are identified by bolding. Text in **bold** refers to items directly from the EV kit software. Text in **bold and underlined** refers to items from the Windows operating system.

### Evaluation Software Installation

Installing the evaluation software for the EV kit on a PC has one or two steps. The first step involves running the EV kit software installer. The second step involves installing the USB driver, and is only necessary when the driver is not already installed on the PC.

**Note:** Do not connect the USB port of the EV kit to the PC until the **MAX3987 Evaluation Kit Setup Wizard** has successfully completed the software installation.

- 1) Run the MAX3987\_REV#. #.msi installer package that was supplied with the EV kit.
- 2) Click **Next** at the welcome screen dialog box. See Figure 3.

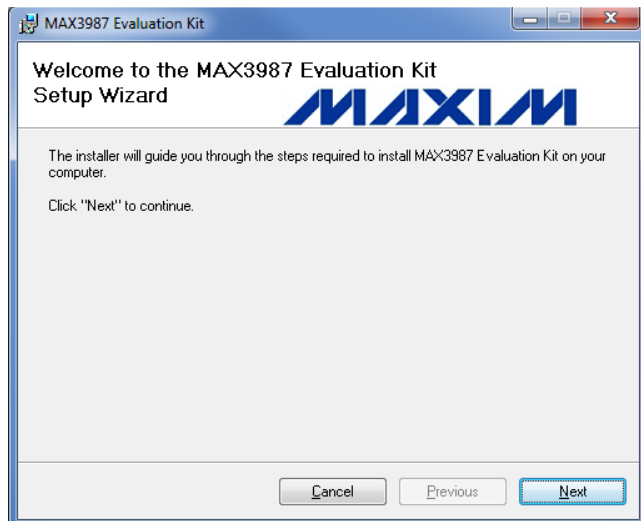

Figure 3. Software Installer Setup Wizard Introduction

- 3) Click **Next** to accept the default destination folder. See Figure 4.

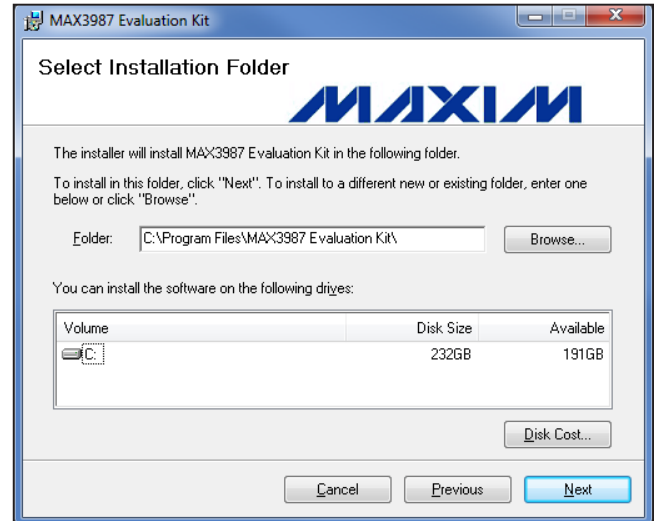

Figure 4. Software Installer Destination Folder Selection

- 4) Click **Next** to begin the software installation. See Figure 5.

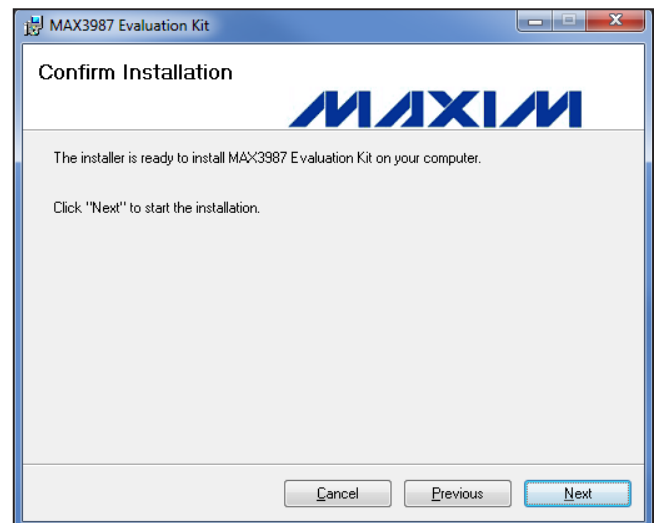

Figure 5. Software Installer Confirm Installation

# MAX3987 Evaluation Kit

5) If the software is installed on a PC with Windows Vista® or Windows 7, a **User Account Control** dialog box appears. Click **Yes** to allow the software installation to continue. See Figure 6. The dialog box switches to a progress bar and indicates that the EV kit software is being installed. The software installation should complete quickly since it is small. See Figure 7.

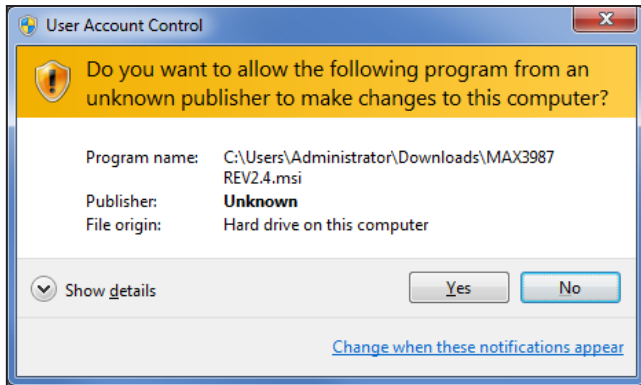

Figure 6. Windows User Account Control Warning

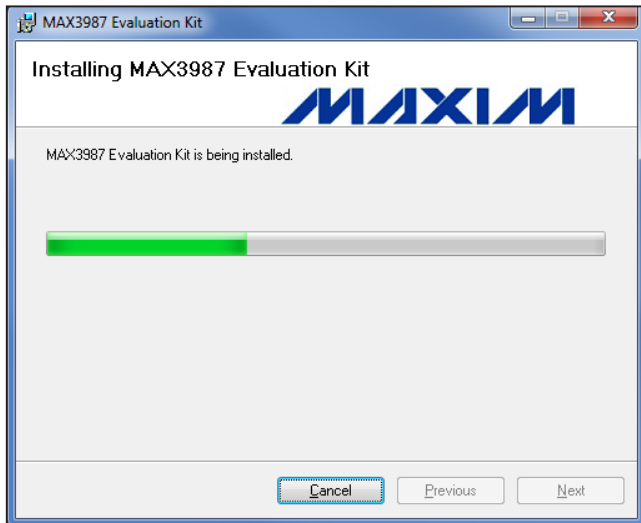

Figure 7. Software Installer Progress Indicator

6) Click **Next** to dismiss the USB driver reminder. See Figure 8.

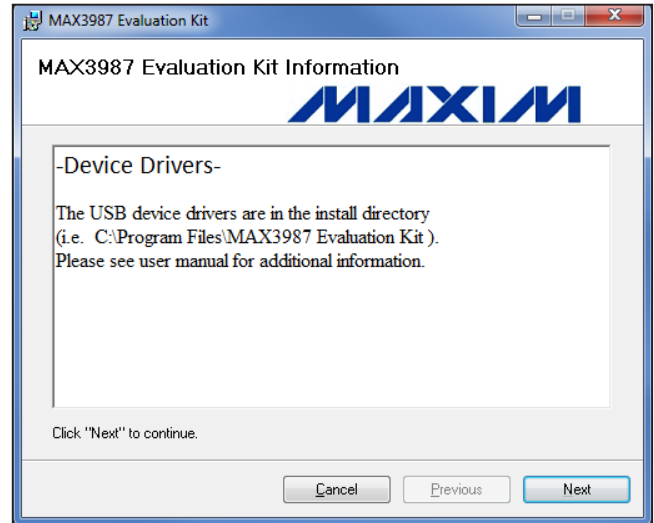

Figure 8. Software Installer USB Driver Reminder

7) Click **Close** to complete the installation and exit the software installer. See Figure 9.

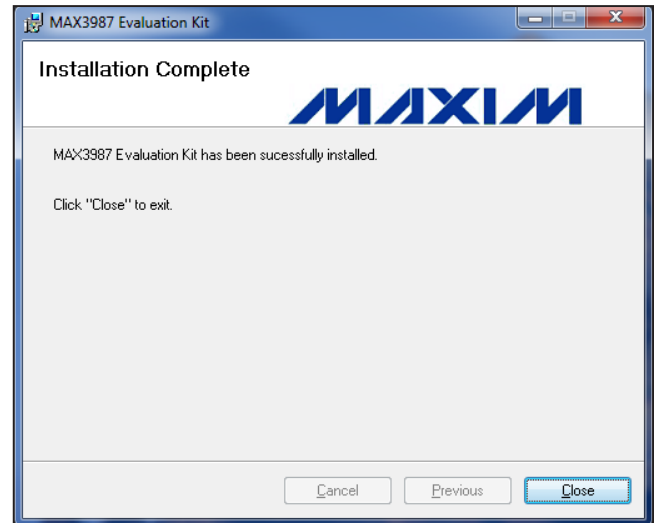

Figure 9. Software Installer Setup Wizard Completion

Windows Vista is a registered trademark of Microsoft Corp.

# MAX3987 Evaluation Kit

Evaluates: MAX3987

8) Connect the USB port of the EV kit to the PC. If this is the first time installing the EV kit software, it is necessary to install the USB driver. There are two sets of driver installation instructions. Follow the steps in the following sections to install on a PC with Windows Vista, Windows 7, or Windows XP®.

## USB Driver Installation (Windows Vista and Windows 7)

When the USB port of the EV kit is connected to a PC with Windows Vista or Windows 7, Windows does not automatically install the driver nor does it start the **Found New Hardware Wizard**. It is necessary to manually install the USB driver using the Windows **Device Manager**.

- 1) Open the Windows **Device Manager**. To do this, use the following path in Windows: **Start**→**Control Panel**→**System and Security**→**System**→**Device Manager**.
- 2) In the **Device Manager** window, there is a section labeled **Other devices** with a device labeled **Unknown device**. Right-click on the **Unknown device** followed by **Update Driver Software**. See Figure 10.

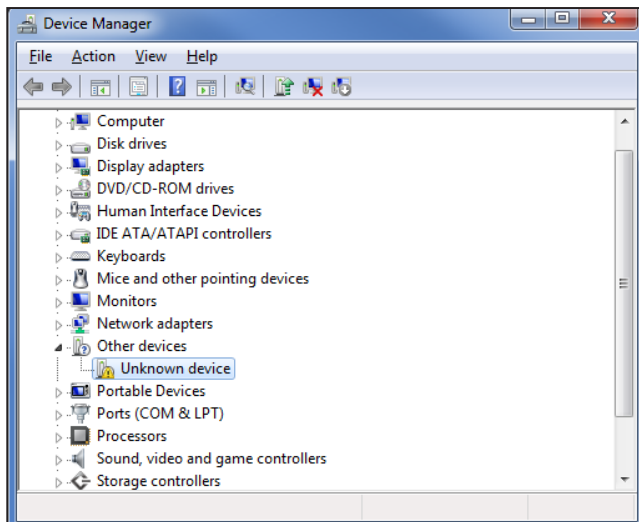

Figure 10. Device Manager Unknown Device Selection

- 3) Click **Browse my computer for driver software** to begin the driver installation. See Figure 11.

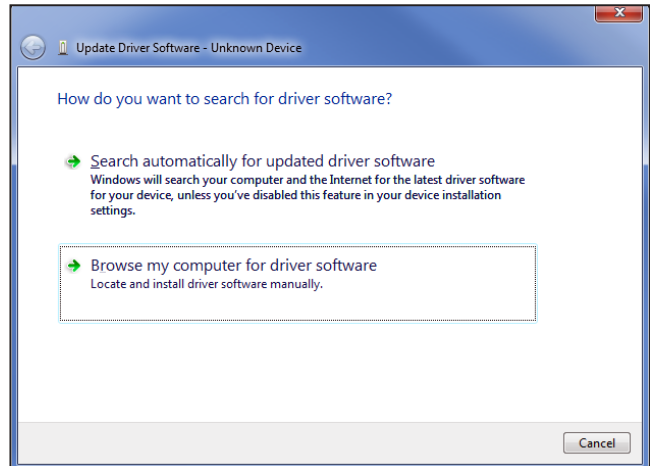

Figure 11. Update Driver Software—Manual Install

- 4) Click the **Browse** button and select the same installation directory used in step 3 of the GUI software installation instructions (the default directory is C:\Program Files\MAX3987 Evaluation Kit). Click **Next** to continue. The **Found New Hardware Wizard** searches for a short duration before continuing with the driver installation. See Figure 12.

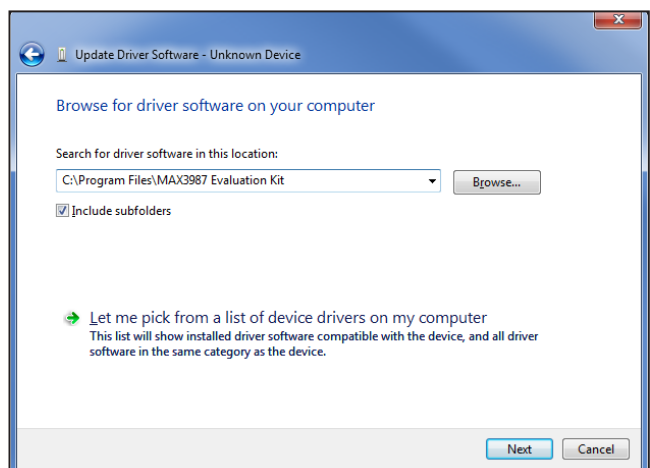

Figure 12. Driver Software Folder Selection

Windows XP is a registered trademark of Microsoft Corp.

# MAX3987 Evaluation Kit

5) A notification that Windows cannot verify the publisher of this driver software appears. This notice is normal, and the driver has been verified to work with Windows Vista and Windows 7. Click **Install this driver software anyway** to continue with the driver installation. See Figure 13. The dialog box switches to a progress bar and indicates that the HC9S08JMxx CDC driver is being installed. The driver installation should complete in a relatively short time. See Figure 14.

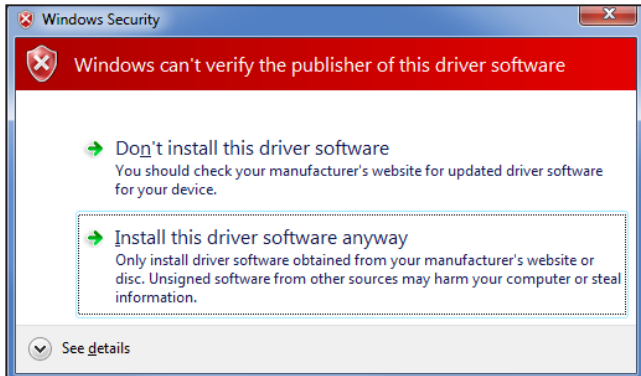

Figure 13. Windows Unverified Publisher Driver Install Warning

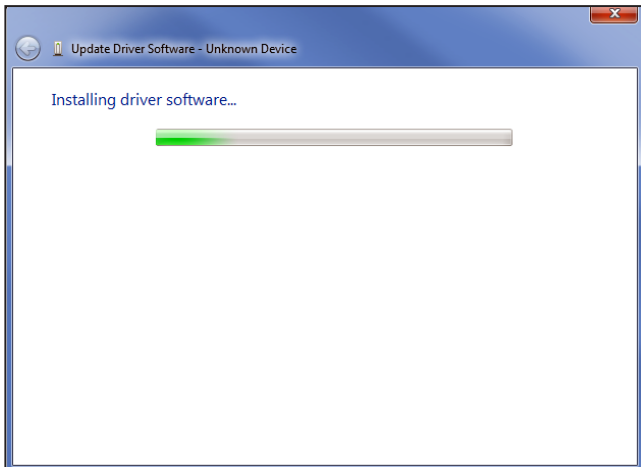

Figure 14. Driver Software Installer Progress Indicator

6) Click **Close** to complete the driver installation and exit the software installer. See Figure 15.

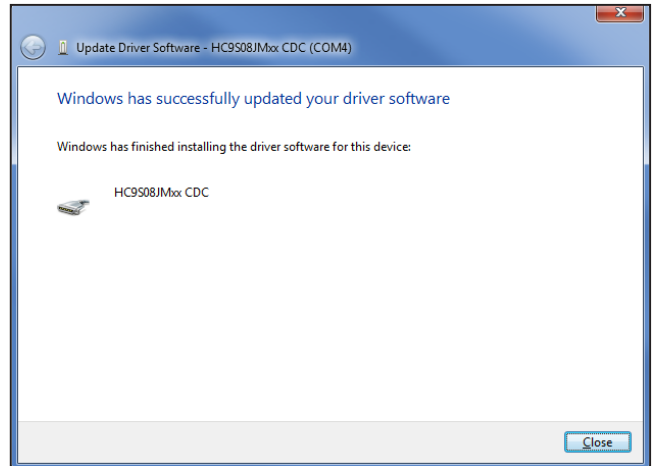

Figure 15. Driver Software Installer Completion

7) The EV kit software and the USB driver are now installed and ready for use.



# MAX3987 Evaluation Kit

## USB Driver Installation (Windows XP)

When the USB port of the EV kit is connected to a PC with Windows XP, Windows automatically launches the **Found New Hardware Wizard**. If Windows does not launch the **Found New Hardware Wizard**, the driver is already installed and the remaining steps are not necessary.

- 1) Check **Install from a list or specific location (Advanced)** and click **Next** to continue. See Figure 16.

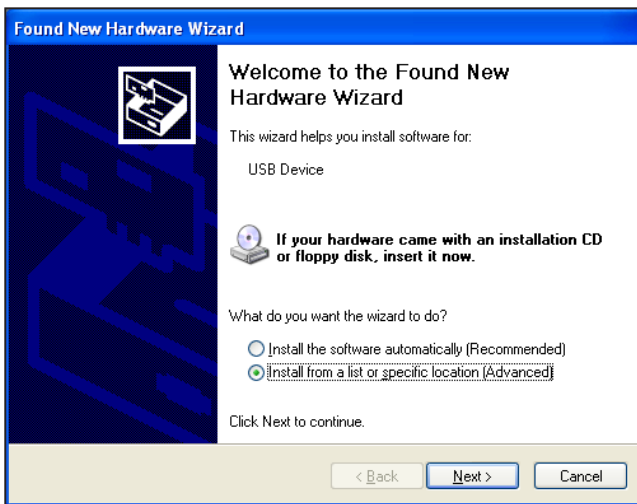

Figure 16. Install Driver Software—Manual Install

- 2) Check **Search for the best driver in these locations**, and check the **Include this location in the search** box. Click the **Browse** button and select the same installation directory used in step 3 of the GUI software installation instructions (the default directory is C:\Program Files\MAX3987 Evaluation Kit). Click **Next** to continue. The **Found New Hardware Wizard** searches for a short duration before continuing with the driver installation. See Figure 17.

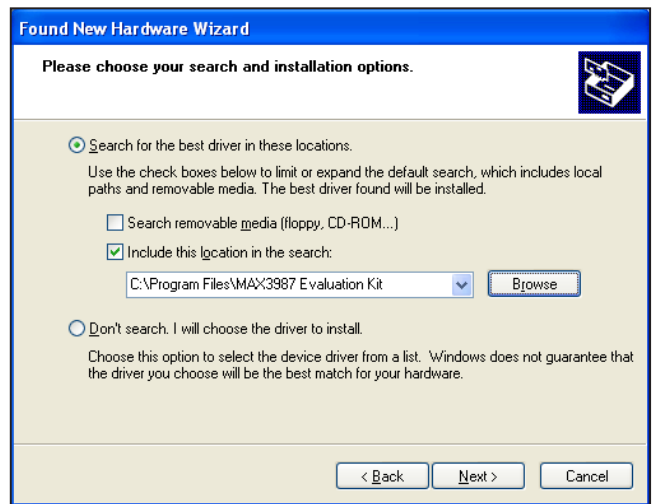

Figure 17. Driver Software Folder Selection

# MAX3987 Evaluation Kit

3) A notification that the driver has not passed Windows Logo testing appears. This notice is normal, and the driver has been verified to work with Windows XP. Click **Continue Anyway** to continue with the driver installation. See Figure 18. The dialog box switches to a progress bar and indicates that the HC9S08JMxx CDC driver is being installed. The driver installation should complete in a relatively short time. See Figure 19.



Figure 18. Windows Logo Testing Driver Install Warning

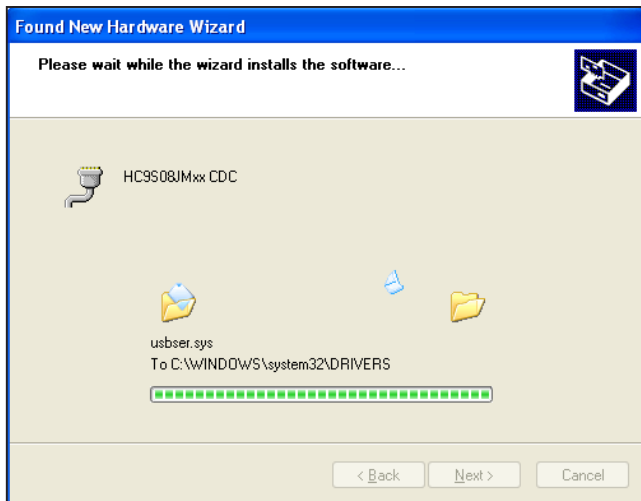

Figure 19. Driver Software Installer Progress Indicator

4) Click **Finish** to complete the driver installation and exit the software installer. See Figure 20.

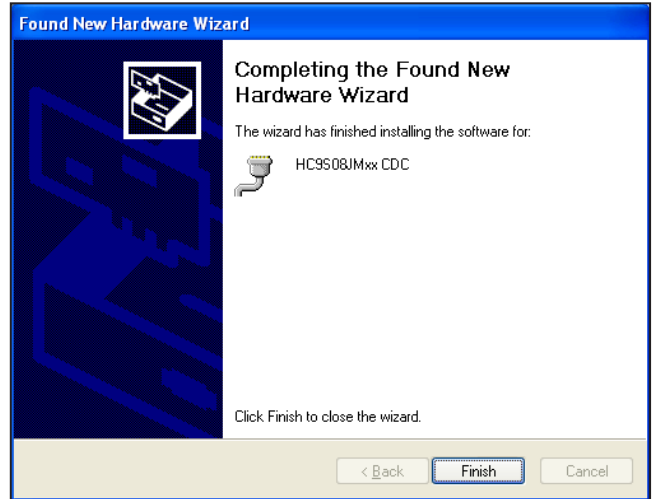

Figure 20. Driver Software Installer Completion

5) The EV kit software and the USB driver are now installed and ready for use.

# MAX3987 Evaluation Kit

Evaluates: MAX3987

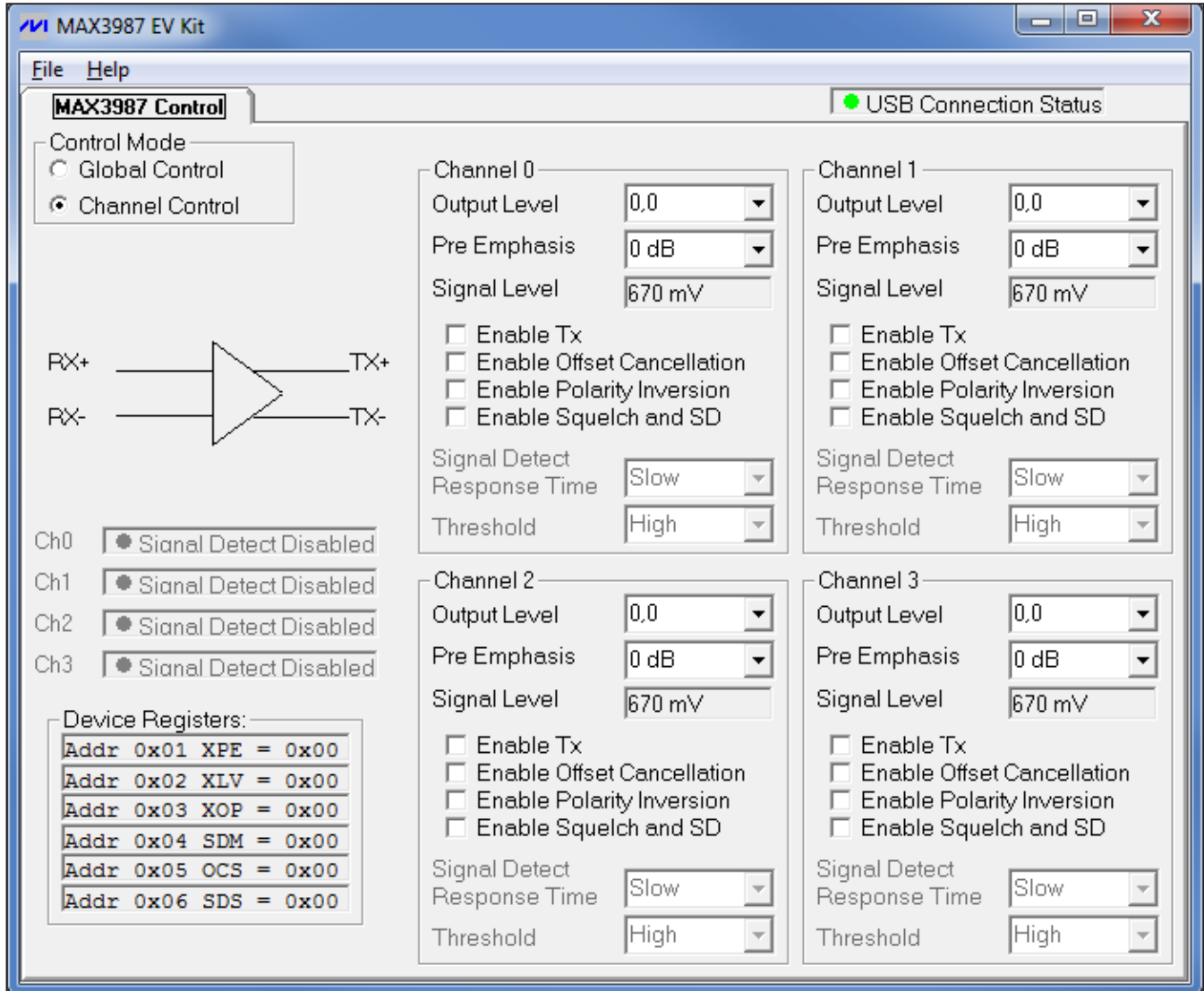

Figure 21. MAX3987 EV Kit Evaluation Software—Individual Channel Control

## GUI Software Interface

- 1) Install a shunt on jumper JP\_ between 5V-USB and BOARD\_POWER to use the USB port power.
- 2) Set the SW2-1 switch labeled I2C\_EN to the OFF position to enable the GUI software mode.
- 3) Connect the computer to the EV kit with a USB cable (A-male to mini-B-male). LED DS1 should illuminate, indicating that the USB power is detected.
- 4) Follow this path in Windows to start the EV kit software: **Start**→**All Programs**→**MAX3987**→**MAX3987 EV Kit**.
- 5) The **USB Connection Status** indicator should turn green. If the indicator remains red, ensure that the USB cable is properly connected to the EV kit.
- 6) The device's 4 channels can be controlled individually (Figure 21) or as a group (Figure 22) using the **Control Mode** selection in the upper left-hand section of the software.

# MAX3987 Evaluation Kit

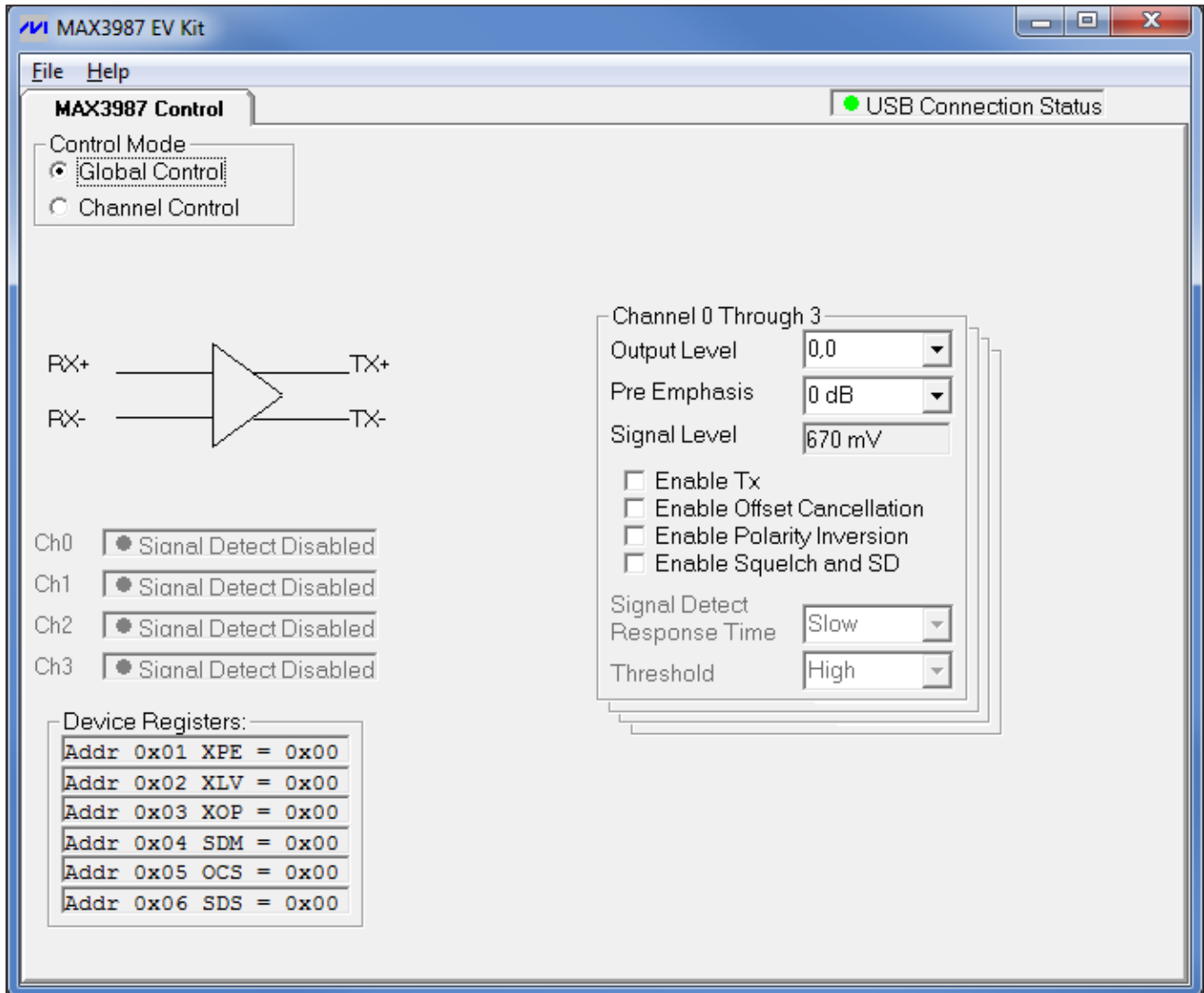

Figure 22. MAX3987 EV Kit Evaluation Software—Global Channel Control

- 7) Using the EV kit software controls, configure the device for the desired mode of operation.
- 8) To begin testing, connect the signal source(s) to any pair of input SMA connectors (RX0–RX3). The differential input signal voltage can be between 200mV<sub>p-p</sub> and 1600mV<sub>p-p</sub> with a data rate from 1Gbps to 8.5Gbps. The output signal(s) can be observed by connecting the associated pair of output SMA connectors (TX0–TX3) to a high-speed oscilloscope with 50Ω termination.
- 9) See Figures 1 and 2 for setup examples for testing and evaluating the device's equalization and pre-emphasis features.

### Connector, Switch, Jumper, and LED Descriptions

The EV kit has several connectors, configuration switches, jumpers, and an LED. Table 4 shows a brief description of these items and, if applicable, includes a default setting.

# MAX3987 Evaluation Kit

Evaluates: MAX3987

**Table 4. Main Board Configuration and Description**

PCB REFERENCE	DEFAULT SETTING	DESCRIPTION
J1	—	Channel 0 Positive CML Differential Data Input Signal (RX0+)
J3	—	Channel 0 Negative CML Differential Data Input Signal (RX0-)
J6	—	Channel 1 Positive CML Differential Data Input Signal (RX1+)
J8	—	Channel 1 Negative CML Differential Data Input Signal (RX1-)
J10	—	Channel 2 Positive CML Differential Data Input Signal (RX2+)
J12	—	Channel 2 Negative CML Differential Data Input Signal (RX2-)
J14	—	Channel 3 Positive CML Differential Data Input Signal (RX3+)
J16	—	Channel 3 Negative CML Differential Data Input Signal (RX3-)
J2	—	Channel 0 Positive CML Output Signal (TX0+)
J4	—	Channel 0 Negative CML Output Signal (TX0-)
J7	—	Channel 1 Positive CML Output Signal (TX1+)
J9	—	Channel 1 Negative CML Output Signal (TX1-)
J11	—	Channel 2 Positive CML Output Signal (TX2+)
J13	—	Channel 2 Negative CML Output Signal (TX2-)
J15	—	Channel 3 Positive CML Output Signal (TX3+)
J17	—	Channel 3 Negative CML Output Signal (TX3-)
SW1	SW1-1 to SW1-8 ON	Hardware Mode: OC_EN input bias (OFF = 3.3V, ON = 0V) Software Mode: I <sup>2</sup> C address (OFF = 3.3V, ON = 0V)
SW2	SW2-1 OFF, SW2-2 to SW2-8 ON	Hardware Mode: I2C_EN, TX_EN, TX_LV[1:0], TX_PE[1:0], SDSF, and SQ input bias (OFF = 3.3V, ON = 0V)
J5	Jumper 1+2, Jumper 3+4	MAX3987 I <sup>2</sup> C Bus, Processor I <sup>2</sup> C Bus, Test Points. Jumper pins 1+2, 3+4 to use on-board processor. Remove for external processor.
JP2	Jumper 2+3	Power Select. Jumper pins 2+3 to power board from the USB connector. Jumper pins 1+2 to power board from the 5V adapter.
JP1	Jumper 1+2	MAX3987 Power Select. Jumper pins 1+2 to power the device with 3.3V. Jumper pins 2+3 to power the device with 2.5V.
J18	Connect to PC	USB Connector. Note that USB power can still be used in hardware mode.
J20	—	5V Wall Adapter
J19	—	Factory Test and Programming
SW3	—	Reset Switch for Only the MAX3987 and Microcontroller
DS1	—	3.3V Power Indicator

## **Additional Information**

### **External Processor Control**

The EV kit is intended to be controlled using the on-board microcontroller in conjunction with a PC running the EV kit evaluation software. However, the EV kit provides additional jumper points that can be used to connect the

device's I<sup>2</sup>C bus to an external processor. By connecting EV kit pins J5.1 and J5.3 to the I<sup>2</sup>C bus of an external processor, it is possible to fully interact with the device. For more information, refer to the MAX3987 IC data sheet at [www.maxim-ic.com/MAX3987](http://www.maxim-ic.com/MAX3987).



# MAX3987 Evaluation Kit

Evaluates: MAX3987

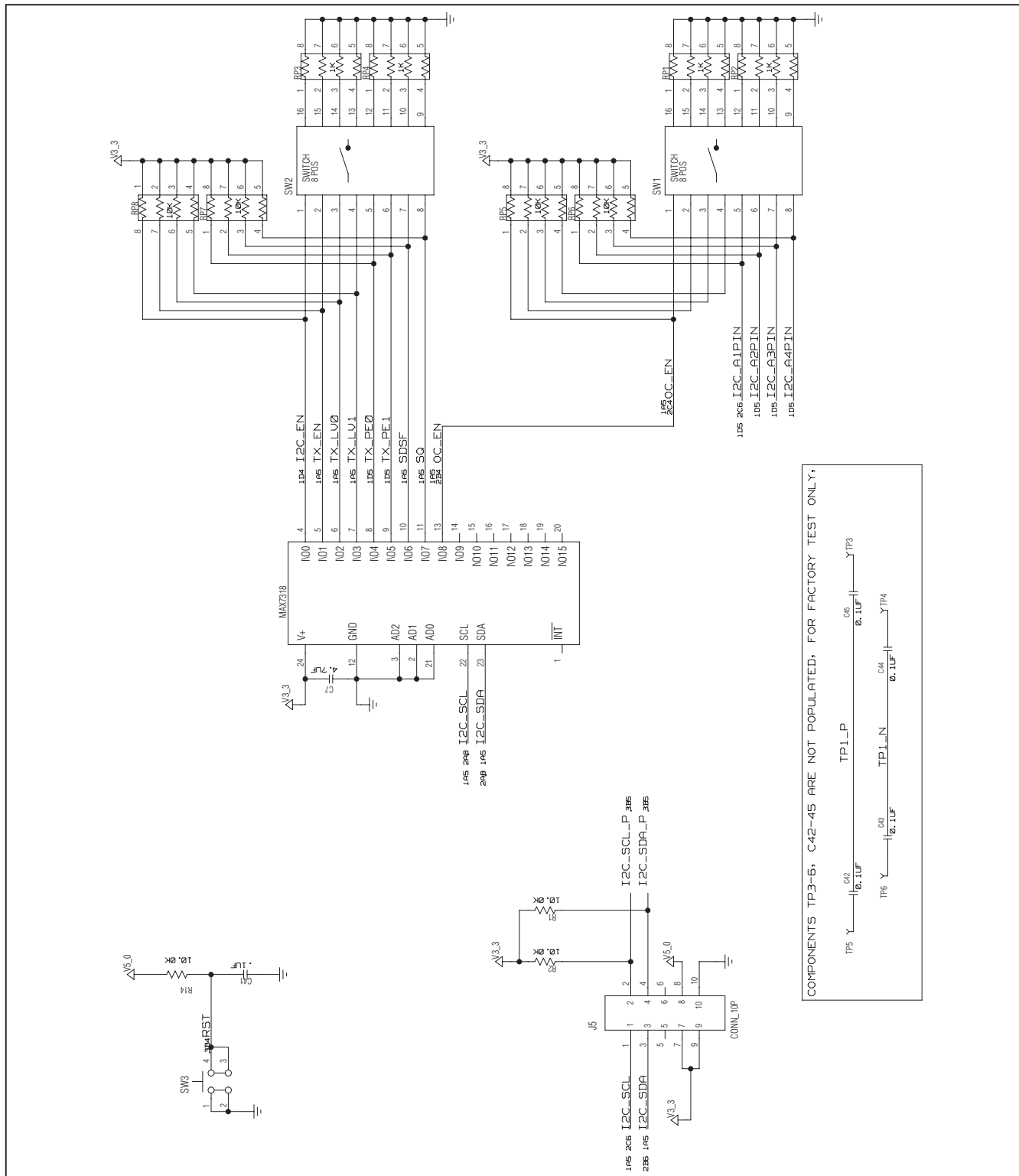

Figure 23b. MAX3987 EV Kit Schematic (Sheet 2 of 3)

## MAX3987 Evaluation Kit

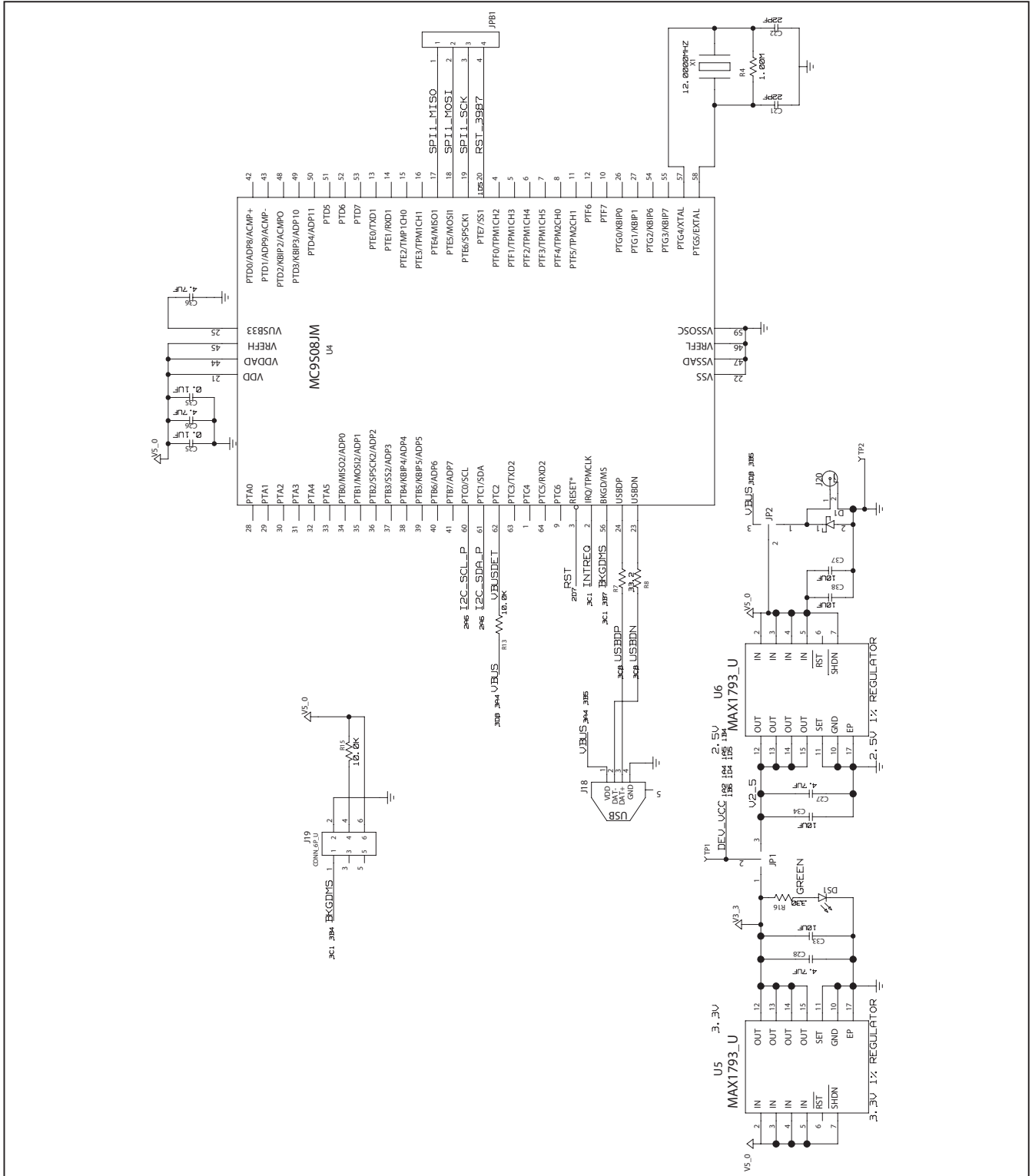

Figure 23c. MAX3987 EV Kit Schematic (Sheet 3 of 3)



# MAX3987 Evaluation Kit

Evaluates: MAX3987

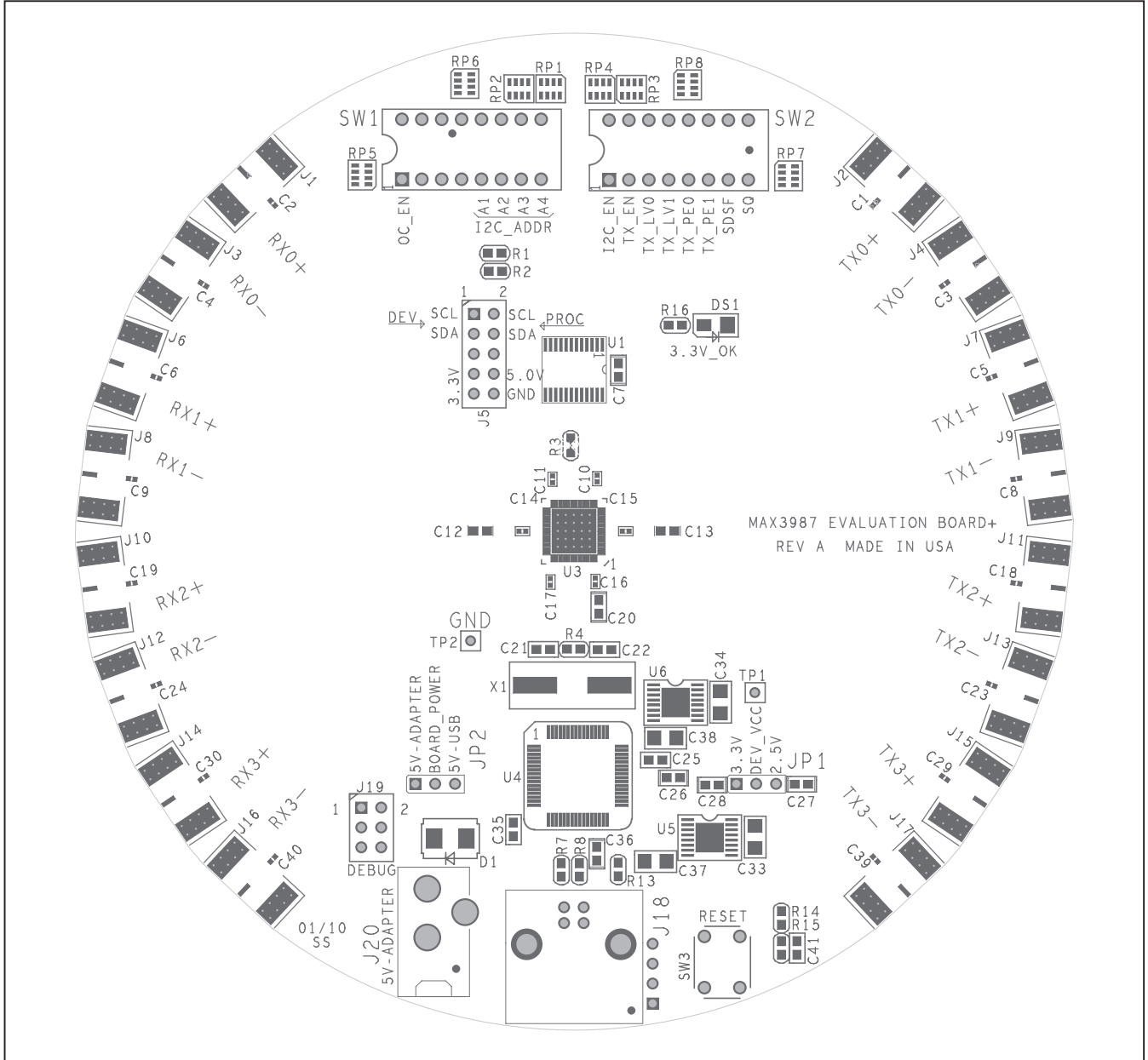

Figure 24a. MAX3987 EV Kit Component Placement Guide—Component Side (Sheet 1 of 2)

# MAX3987 Evaluation Kit

Evaluates: MAX3987

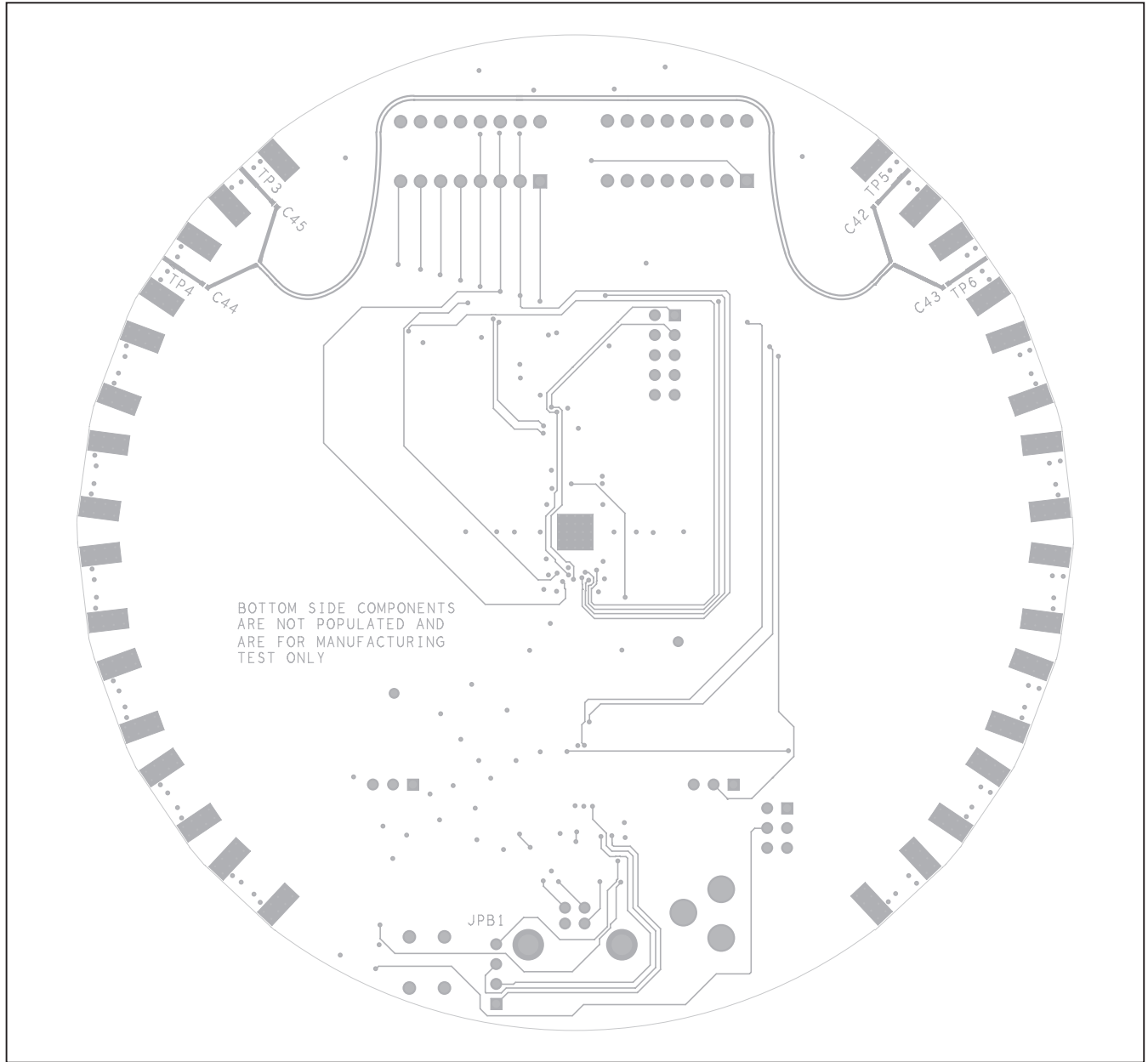

Figure 24b. MAX3987 EV Kit Component Placement Guide—Solder Side (Sheet 2 of 2)

# MAX3987 Evaluation Kit

Evaluates: MAX3987

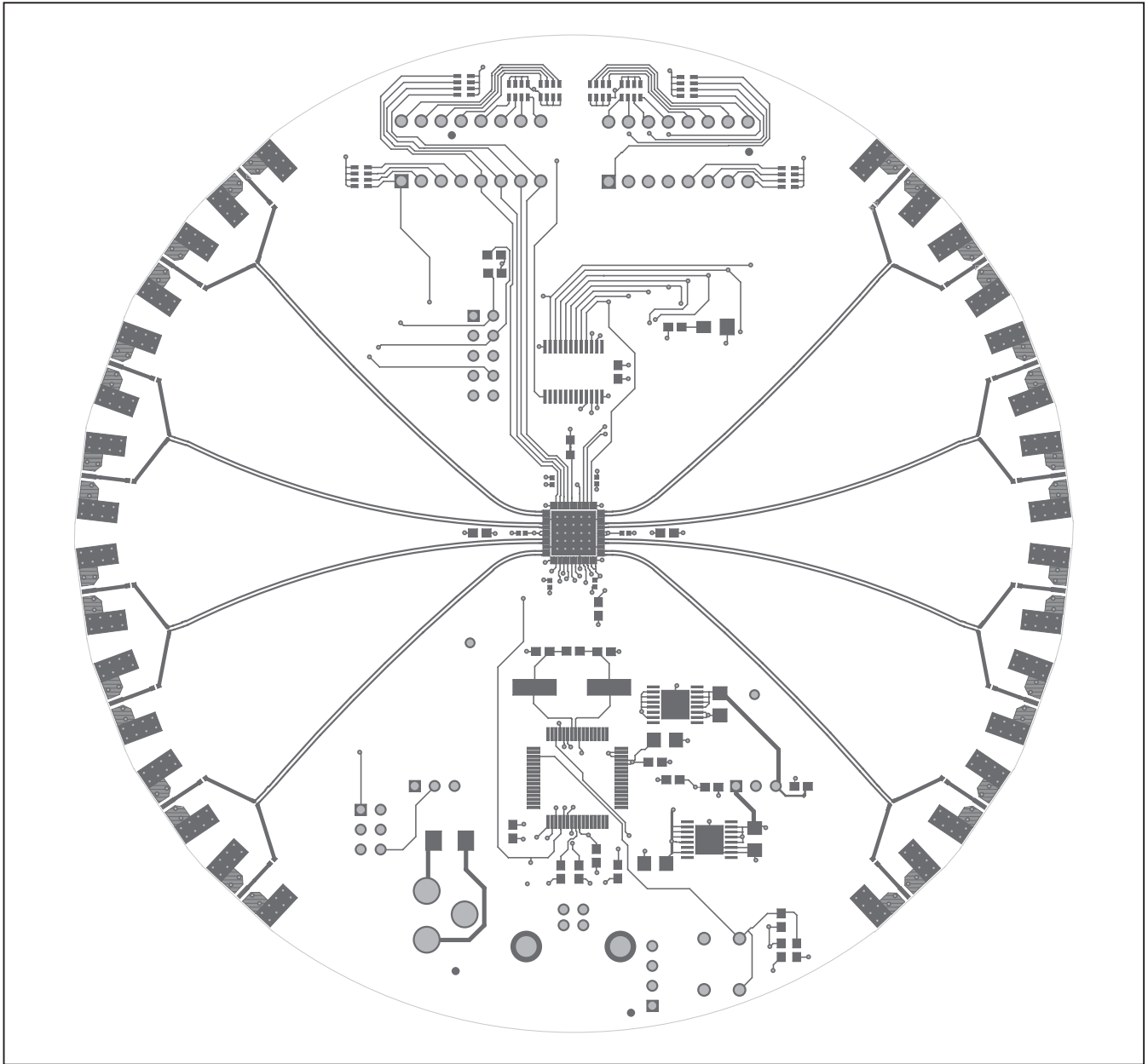

Figure 25a. MAX3987 EV Kit PCB Layout—Component Side (Sheet 1 of 4)

# MAX3987 Evaluation Kit

Evaluates: MAX3987

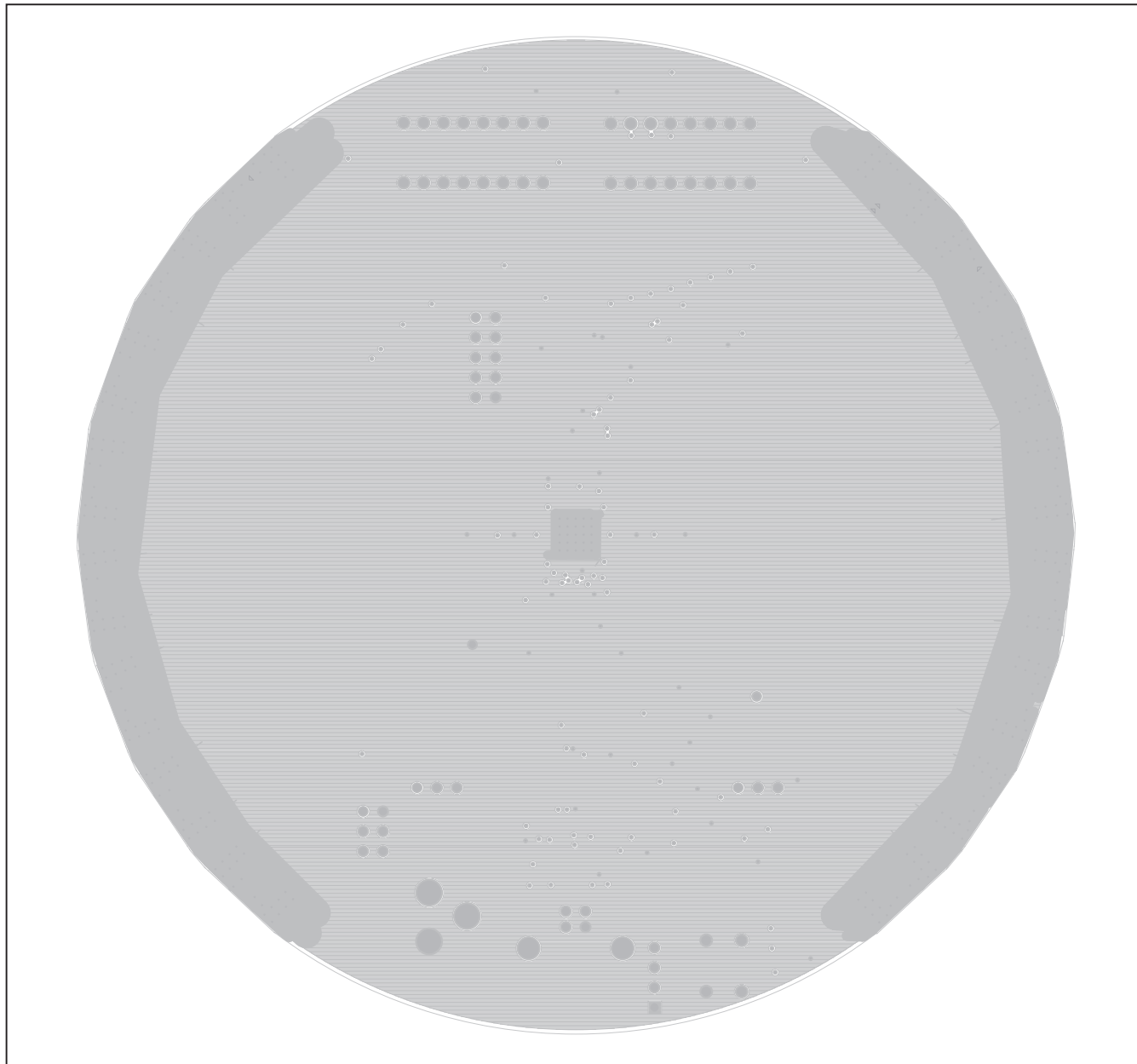

Figure 25b. MAX3987 EV Kit PCB Layout—Ground Plane (Sheet 2 of 4)

# MAX3987 Evaluation Kit

Evaluates: MAX3987

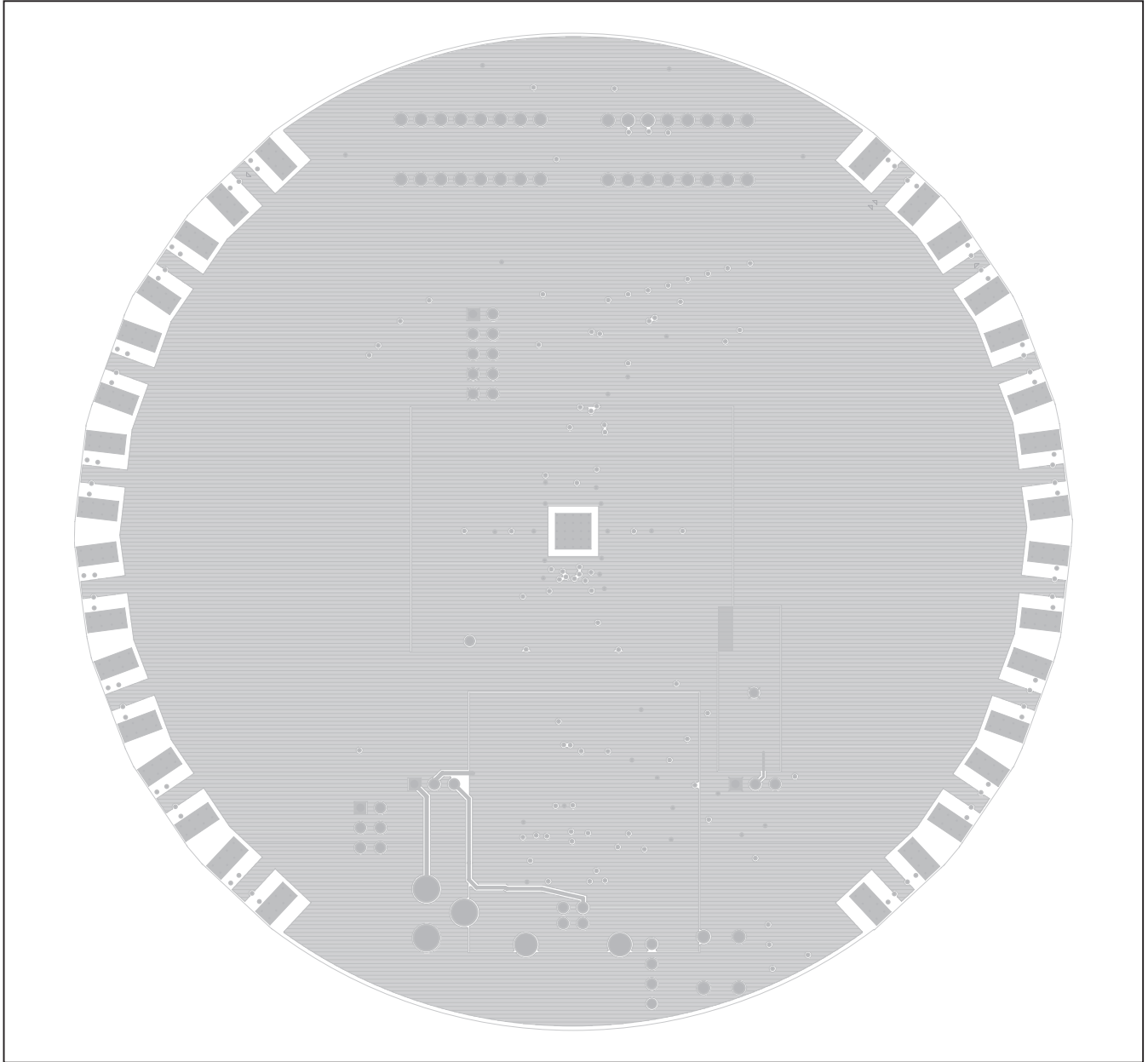

Figure 25c. MAX3987 EV Kit PCB Layout—Power Plane (Sheet 3 of 4)

# MAX3987 Evaluation Kit

Evaluates: MAX3987

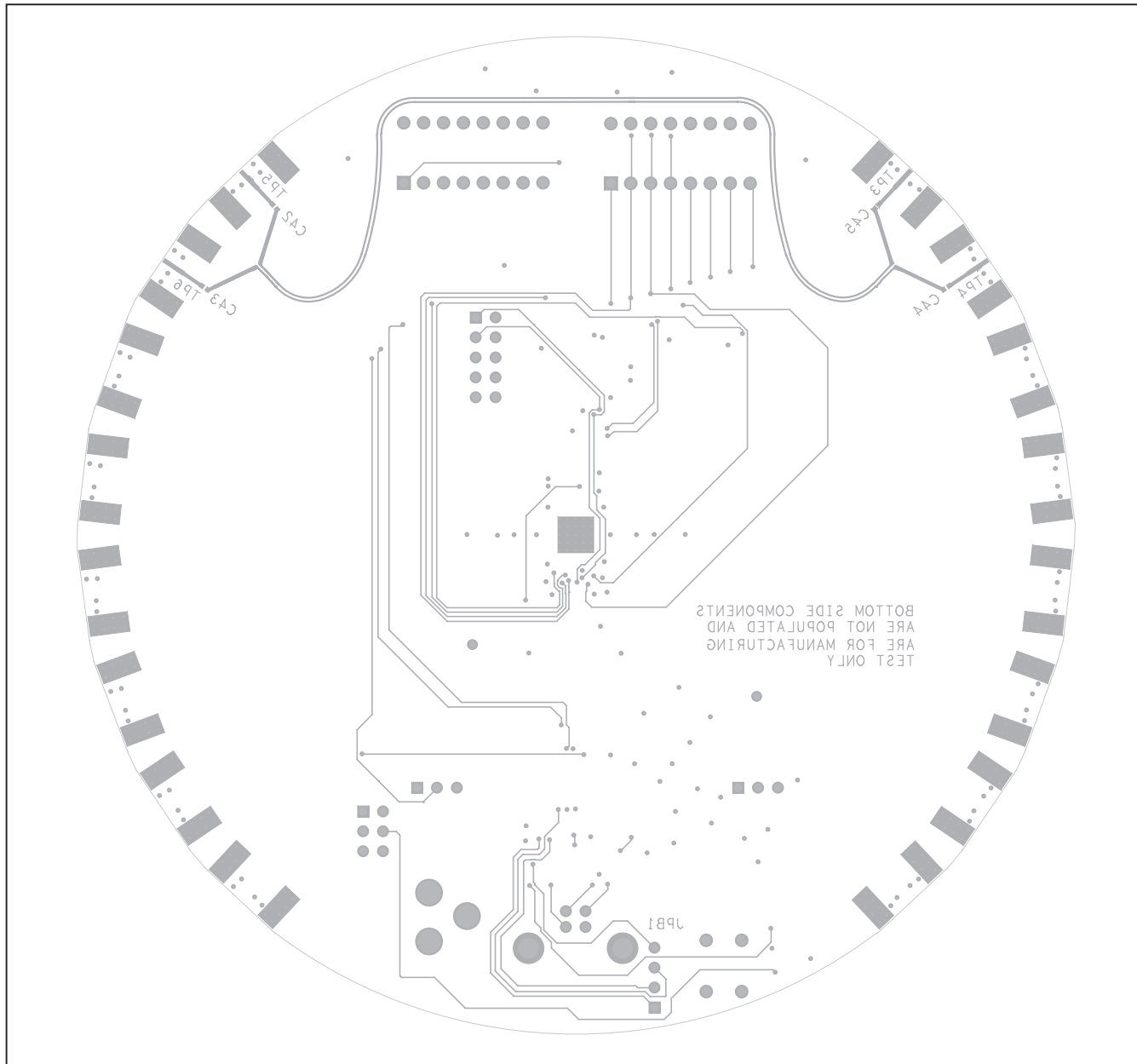

Figure 25d. MAX3987 EV Kit PCB Layout—Solder Side (Sheet 4 of 4)

# MAX3987 Evaluation Kit

## Revision History

REVISION NUMBER	REVISION DATE	DESCRIPTION	PAGES CHANGED
0	9/10	Initial release	—

Evaluates: MAX3987

*Maxim cannot assume responsibility for use of any circuitry other than circuitry entirely embodied in a Maxim product. No circuit patent licenses are implied. Maxim reserves the right to change the circuitry and specifications without notice at any time.*

**Maxim Integrated Products, 120 San Gabriel Drive, Sunnyvale, CA 94086 408-737-7600 \_\_\_\_\_ 23**